

Merrill Lynch Advice & Guidance Web Site

Proposed Sitemap and Wireframes



1936 Broadway, 5th Floor, New York, NY 10010
Tel 212 258 9200 Fax 212 258 9200 www.hnw.com

The information contained in this document is confidential and proprietary and may not be shared with anyone outside without prior permission.

© 2010

Table of Content

1	Cover
2	Table of Content
3	Proposed Site Map
4	Home
5	Outlook 2011
6	Advisor Resource Center
7	Email Campaign Manager
8	Investment Resources
9	Webcasts for Clients
10	Broadcasts
11	Broadcast Detail

HNW TEAM

Heather McKim
SVP, Strategy & Interactive
Direct 212.258.9241
hmckim@hnw.com

Pawel Tulin
Vice President, User Experience
Direct 212.258.9277
ptulin@hnw.com@hnw.com

Monika Smyczek
Associate Director, Project Management
Direct 212.258.9250
msmyczek@hnw.com

DOCUMENT AUTHORS

Pawel Tulin
Vice President, User Experience
Direct 212.258.9277
ptulin@hnw.com@hnw.com

Proposed Site Map

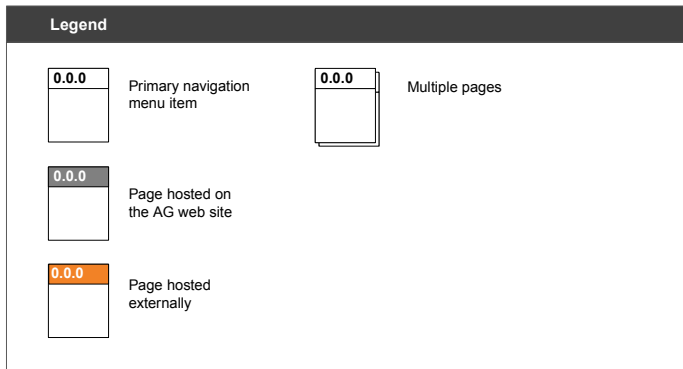
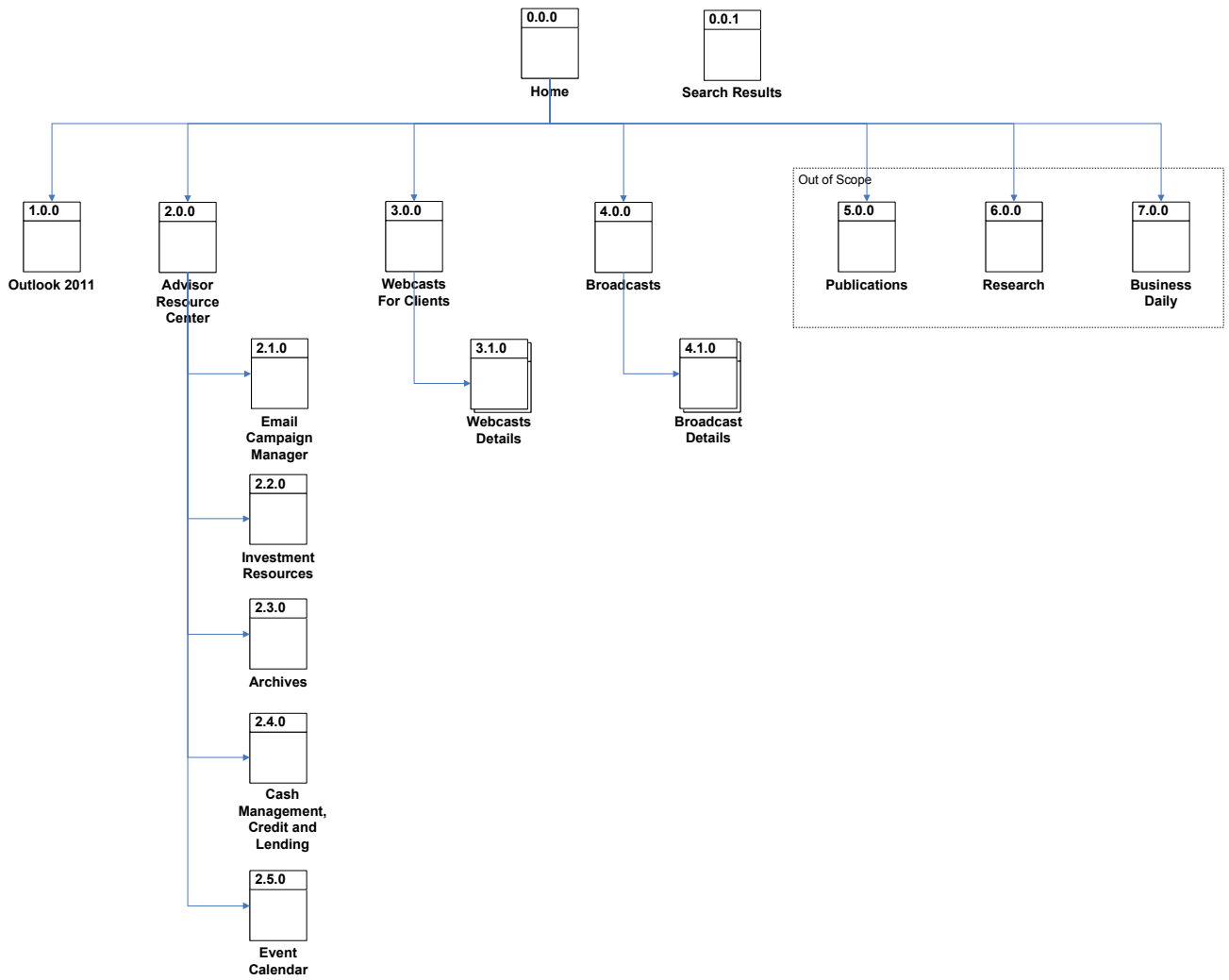

Search

Welcome User User

HomeOutlook 2011Advisor Resource CenterWebcasts For ClientsBroadcastsPublicationsResearchBusiness DailyInvestment Management and Guidance

Advice and Guidance

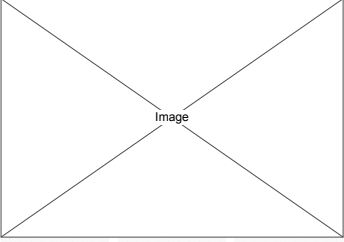

Introduction

Lorem ipsum dolor sit amet, consectetur adipiscing elit, sed do eiusmod tempor incididunt ut labore et dolore magna aliqua.

Ut enim ad minim veniam, quis nostrud exercitation ullamco laboris nisi ut aliquip ex ea commodo consequat. Duis aute irure dolor in reprehenderit in voluptate velit esse cillum dolore eu fugiat nulla pariatur.

Excepteur sint occaecat cupidatat non proident, sunt in culpa qui officia deserunt mollit anim id est laborum

Contacts

See all

Suggestions? - [Email GWM Advice & Guidance](#)

Portfolio Strategies Desk (PSD): (212) 449-5744

[Wealth Management Specialist Directory](#)

WMB Internal Sales Desk:(888) ML-BANKU (652-2658)

MLSN: (866) ML-SERVICE (657-3784)

[GWM Investment Management & Guidance Website](#)

Outlook 2011

[Guide](#)
sed do eiusmod tempor incididunt ut labore et

[Conference Call](#)
Lorem ipsum dolor sit amet, consectetur adipiscing elit, sed do eiusmod tempor incididunt ut labore et dolore magna aliqua.

[Seminar](#)
Ut enim ad minim veniam, quis nostrud exercitation ullamco laboris nisi ut aliquip ex ea

Featured Webcast

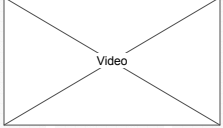

Title - Dolor sit amet, consectetur adipiscing elit, sed do eiusmod tempor incididunt ut labore ...

News and alerts

[View all news and alerts](#)

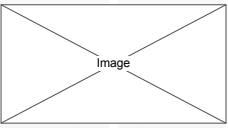

Title [📄](#)
00/00/0000

Lorem ipsum dolor sit amet, consectetur adipiscing elit, sed do eiusmod tempor incididunt ut labore et dolore magna aliqua. Ut enim ad minim veniam, quis nostrud exercitation ullamco laboris n..... [See more](#)

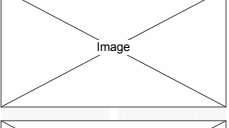

Title [📄](#)
00/00/0000

Lorem ipsum dolor sit amet, consectetur adipiscing elit, sed do eiusmod tempor incididunt ut labore et dolore magna aliqua. Ut enim ad minim veniam, quis nostrud exercitation ullamco laboris n..... [See more](#)

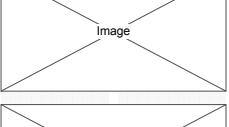

Title [📄](#)
00/00/0000

Lorem ipsum dolor sit amet, consectetur adipiscing elit, sed do eiusmod tempor incididunt ut labore et dolore magna aliqua. Ut enim ad minim veniam, quis nostrud exercitation ullamco laboris n..... [See more](#)

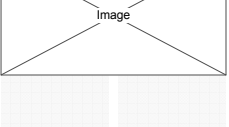

Title [📄](#)
00/00/0000

Lorem ipsum dolor sit amet, consectetur adipiscing elit, sed do eiusmod tempor incididunt ut labore et dolore magna aliqua. Ut enim ad minim veniam, quis nostrud exercitation ullamco laboris n..... [See more](#)

Event Calendar

See all

Jan 16, 2011

[Title](#)

Lorem ipsum dolor sit amet, consectetur adipiscing elit, sed do eiusmod tempor incididunt ut labore et dolore magna aliqua...

[More.....](#)

Your Saved Publications

Most Popular Publications

See all

Quick Links

Advisor Resource Center

Duis aute irure dolor in reprehenderit in voluptate velit esse cillum dolore eu fugiat nulla pariatur. Excepteur sint occaecat cupidatat non proident, sunt in culpa qui officia deserunt mollit anim id est laborum Et harum und lookum like Greek to me, dereud facilis est er expedit distinct. Nam liber te conscient to factor tum poen legum odioqueviuuda.

[view](#)

Email Campaign Manager

View

Use the Email Campaign Manager to invite Clients & Prospects to watch the client Webcasts.

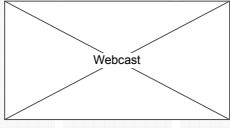

IMG Implementation Guide

The Implementation Guide suite matches the best ideas from ML Research with IMG's high conviction implementation.

[Investment By Theme »](#)
[Total Solutions »](#)
[Total Solutions with FA Choice »](#)

Footer

INTERACTION NOTES

Homepage focuses on the introduction to the site and highlights main campaigns (Outlook 2011) as well as current News and Alerts. Additional functions are moved to the right rail as reusable modules which can be used in other sections of the site.

Page fold



Logo and Branding

Welcome User User

Home Outlook 2011 Advisor Resource Center Webcasts For Clients Broadcasts Publications Research Business Daily Investment Management and Guidance

Home > Outlook 2011 Print

Outlook 2011

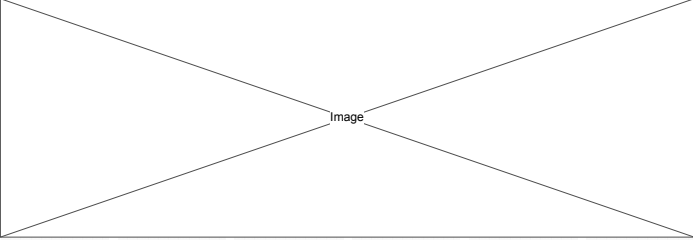

Image

Officia deserunt mollit anim id est laborum Et harum dereud facilis est er expedit distinct. Nam liber te conscient to factor tum poen legum odioque civiuda et tam. Neque pecun modut est neque nonor et imper ned libidig met. consectetur adipiscing elit, sed ut labore et dolore magna aliquam is nostrud exercitation ullam mmodo consequet. Duis aute in voluptate velit esse cillum dolore eu fugiat nulla pariatur. At vver eos et accusam dignissim qui blandit est praesent. Trenz pruca beynocguon doas nog apoply su trenz ucu hugh rasolugouon monugor or trenzucugwo jag scannar.

▶ Whitepapers

Nam liber te conscient to factor tum poen legum odioqueciviuda.

▶ Conference Calls

Ut enim ad minimveniam, quis nostrud exercitation ullamco laboris nisi ut aliquip ex ea commodo consequat.

▶ Research Roadshows

Et harum und lookum like Greek to me, dereud facilis est er expedit distinct.

▶ Monthly publications

Excepteur sint occaecat cupidatat non proident, sunt in culpa qui officia deserunt mollit anim id estlaborum

▶ IMC Lists

Excepteur sint occaecat cupidatat non proident, sunt in culpa qui officia deserunt mollit anim id estlaborum

▶ Ads

Et harum und lookum like Greek to me, dereud facilis est er expedit distinct.

▶ Invites

Nam liber te conscient to factor tum poen legum odioqueciviuda.

▶ PDFs

Lorem ipsum dolor sit amet, consectetur adipiscing elit, sed do eiusmod tempor incididunt ut labore et dolore magna aliqua.

▶ Powerpoints

Ut enim ad minimveniam, quis nostrud exercitation ullamco laboris nisi ut aliquip ex ea commodo consequat.

▶ Webcasts/Broadcasts

Duis aute inure dolor in reprehenderit in voluptate velit esse cillum dolore eu fugiat nulla pariatur.

▶ Direct Mail kits

Excepteur sint occaecat cupidatat non proident, sunt in culpa qui officia deserunt mollit anim id estlaborum

▶ Implementation Guides

Et harum und lookum like Greek to me, dereud facilis est er expedit distinct.

▼ Contacts See all

Suggestions? - [Email GWM Advice & Guidance](#)

Portfolio Strategies Desk (PSD): (212) 449-5744

[Wealth Management Specialist Directory](#)

WMB Internal Sales Desk:(888) ML-BANKU (652-2658)

MLSN: (866) ML-SERVICE (657-3784)

[GWM Investment Management & Guidance Website](#)

▼ Event Calendar See all

Jan 16, 2011

Title

Lorem ipsum dolor sit amet, consectetur adipiscing elit, sed do eiusmod tempor incididunt ut labore et dolore magna aliqua...

[More.....](#)

▶ Your Saved Publications

▶ Most Popular Publications See all

▼ Email Campaign Manager View

Use the Email Campaign Manager to invite Clients & Prospects to watch the client Webcasts.

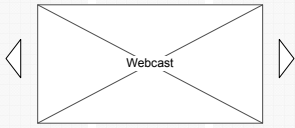

Webcast

▼ IMG Implementation Guide

The Implementation Guide suite matches the best ideas from ML Research with IMG's high conviction implementation:

- [Investment By Theme](#)
- [Total Solutions](#)
- [Total Solutions with FA Choice](#)

Footer

INTERACTION NOTES

Outlook 2011 is a new page that provides an overview of the campaign as well as one stop resource for related materials

Merrill Lynch Advice & Guidance Web Site
Information Architecture
Published: May 10, 2012
Confidential material.
No distribution without prior permission.

hnhw Page 5 of 11

Note: These information architecture layouts are for informational purposes only. All screen sizes are approximate. All visual design elements and copywriting are not final.

Logo and Branding

Search

Welcome User User

Home Outlook 2011 Advisor Resource Center Webcasts For Clients Broadcasts Publications Research Business Daily

Investment Management and Guidance

[Home](#) > [Advisor Resource Center](#) [Print](#)

Advisor Resource Center

Header

Lorem ipsum dolor sit amet, consectetur adipisicing elit, sed do eiusmod tempor incididunt ut labore et dolore magna aliqua. Ut enim ad minim veniam, quis nostrud exercitation ullamco laboris nisi ut aliquip ex ea commodo consequat. Duis aute irure dolor in reprehenderit in voluptate velit esse cillum dolore eu fugiat nulla pariatur. Excepteur sint occaecat cupidatat non proident, sunt in culpa qui officia deserunt mollit anim id est laborum Et harum und lookum like Greek to me, dereud facilis est er expedit distinct. Nam liber te conscient to factor tum poen legum odioqueciuida.

Your Tools [View all tools](#)

<p>Email Webcasts to Your Clients</p> <p>Lorem ipsum dolor sit amet, consectetur adipisicing elit, sed do eiusmod tempor incididunt ut labore et dolore magna aliqua. Ut enim ad minim veniam, quis nostrud exercitation ullamco laboris n.....</p> <p style="text-align: right;">See more</p>	<p>Investment Resources</p> <p>Lorem ipsum dolor sit amet, consectetur adipisicing elit, sed do eiusmod tempor incididunt ut labore et dolore magna aliqua. Ut enim ad minim veniam, quis nostrud exercitation ullamco laboris n.....</p> <p style="text-align: right;">See more</p>
<p>Cash Management, Credit and Lending</p> <p>Lorem ipsum dolor sit amet, consectetur adipisicing elit, sed do eiusmod tempor incididunt ut labore et dolore magna aliqua. Ut enim ad minim veniam, quis nostrud exercitation ullamco laboris n.....</p> <p style="text-align: right;">See more</p>	<p>Archives</p> <p>Lorem ipsum dolor sit amet, consectetur adipisicing elit, sed do eiusmod tempor incididunt ut labore et dolore magna aliqua. Ut enim ad minim veniam, quis nostrud exercitation ullamco laboris n.....</p> <p style="text-align: right;">See more</p>

Contacts

[Suggestions?](#) - [Email GWM Advice & Guidance](#)

Portfolio Strategies Desk (PSD): (212) 449-5744

[Wealth Management Specialist Directory](#)

WMB Internal Sales Desk:(888) ML-BANKU (652-2658)

MLSN: (866) ML-SERVICE (657-3784)

[GWM Investment Management & Guidance Website](#)

Event Calendar

Jan 16, 2011

Title

Lorem ipsum dolor sit amet, consectetur adipisicing elit, sed do eiusmod tempor incididunt ut labore et dolore magna aliqua...

[More.....](#)

[Your Saved Publications](#)

[Most Popular Publications](#) [See all](#)

Email Campaign Manager

[View](#)

Use the Email Campaign Manager to invite Clients & Prospects to watch the client Webcasts.

IMG Implementation Guide

The Implementation Guide suite matches the best ideas from ML Research with IMG's high conviction implementation:

[Investment By Theme »](#)
[Total Solutions »](#)
[Total Solutions with FA Choice »](#)

Your Resources

Thought Leadership

Amet, consectetur adipisicing elit, sed do eiusmod tempor incididunt ut labore et dolore magna aliqua. Ut enim ad minim veniam, quis nostrud exercitation ullamco laboris n.....

<p>Market Volatility</p> <p>Lorem ipsum dolor sit amet, consectetur adipisicing elit, sed do eiusmod tempor incididunt ut labore et dolore magna aliqua. Ut enim ad minim veniam, quis nostrud</p>	<p>Rising Taxes/Bottoming of Interest Rates</p> <p>Excepteur sint occaecat Cupidatat non proident, sunt in culpa qui officia deserunt mollit anim id est laborum</p>	<p>High Quality Global/Multinationals</p> <p>Nam liber te conscient To factor tum poen legum odioqueciuida.</p>
---	---	--

Seminars

Amet, consectetur adipisicing elit, sed do eiusmod tempor incididunt ut labore et dolore magna aliqua. Ut enim ad minim veniam, quis nostrud exercitation ullamco laboris n.....

<p>Market Volatility</p> <p>Lorem ipsum dolor sit amet, consectetur adipisicing elit, sed do eiusmod tempor incididunt ut labore et dolore magna aliqua.</p>	<p>Rising Taxes/Bottoming of Interest Rates</p> <p>Excepteur sint occaecat Cupidatat non proident, sunt in culpa</p>	<p>High Quality Global/Multinationals</p> <p>Nam liber te conscient To factor tum poen legum odioqueciuida.</p>
---	---	--

Client Events

Amet, consectetur adipisicing elit, sed do eiusmod tempor incididunt ut labore et dolore magna aliqua. Ut enim ad minim veniam, quis nostrud exercitation ullamco laboris n.....

<p>Market Volatility</p> <p>Lorem ipsum dolor sit amet, consectetur adipisicing elit, sed do eiusmod tempor incididunt ut labore et dolore magna aliqua.</p>	<p>Rising Taxes/Bottoming of Interest Rates</p> <p>Excepteur sint occaecat Cupidatat non proident, sunt in culpa</p>	<p>High Quality Global/Multinationals</p> <p>Nam liber te conscient To factor tum poen legum odioqueciuida.</p>
---	---	--

Other Resources

Amet, consectetur adipisicing elit, sed do eiusmod tempor incididunt ut labore et dolore magna aliqua. Ut enim ad minim veniam, quis nostrud exercitation ullamco laboris n.....

<p>Market Volatility</p> <p>Lorem ipsum dolor sit amet, consectetur adipisicing elit, sed do eiusmod tempor incididunt ut labore et dolore magna aliqua. Ut enim ad minim veniam, quis nostrud</p>	<p>Rising Taxes/Bottoming of Interest Rates</p> <p>Excepteur sint occaecat Cupidatat non proident, sunt in culpa qui officia deserunt mollit anim id est laborum</p>	<p>High Quality Global/Multinationals</p> <p>Nam liber te conscient To factor tum poen legum odioqueciuida.</p>
---	---	--

Footer

INTERACTION NOTES

Advisor Resource Manager is a repository of tools and resources available to advisors

Merrill Lynch Advice & Guidance Web Site
 Information Architecture
 Published: May 10, 2012
 Confidential material.
 No distribution without prior permission.

Note: These information architecture layouts are for informational purposes only. All screen sizes are approximate. All visual design elements and copywriting are not final.

Email Campaign Manager

Logo and Branding

Welcome User User

HomeOutlook 2011Advisor Resource CenterWebcasts For ClientsBroadcastsPublicationsResearchBusiness DailyInvestment Management and Guidance

Print

Email Campaign Manager

Email Webcasts to Your Clients

Email to:

Enter emails

Reset Send

[View Sample Email](#)

▼ Contacts See all

Suggestions? - [Email GWM Advice & Guidance](#)

Portfolio Strategies Desk (PSD): (212) 449-5744

[Wealth Management Specialist Directory](#)

WMB Internal Sales Desk:(888) ML-BANKU (652-2658)

MLSN: (866) ML-SERVICE (657-3784)

[GWM Investment Management & Guidance Website](#)

▼ Event Calendar See all

Jan 16, 2011

Title

Lorem ipsum dolor sit amet, consectetur adipiscing elit, sed do eiusmod tempor incididunt ut labore et dolore magna aliqua...

[More.....](#)

▶ Your Saved Publications

▶ Most Popular Publications See all

▼ Advisor Resource Center

Duis aute irure dolor in reprehenderit in voluptate velit esse cillum dolore eu fugiat nulla pariatur. Excepteur sint occaecat cupidatat non proident, sunt in culpa qui officia deserunt mollit anim id est laborum Et harum und lockum like Creek to me, dereud facilis est er expedit distinct. Nam liber te conscient to factor tum poen legum odioqueciuida.

[view](#)

▼ IMG Implementation Guide

The Implementation Guide suite matches the best ideas from ML Research with IMG's high conviction implementation:

[Investment By Theme »](#)
[Total Solutions »](#)
[Total Solutions with FA Choice »](#)

Footer

INTERACTION NOTES

Email Campaign Manager allows advisors to email webcasts to their clients.

Recommended: Email Campaign Manager should be embedded in the I-Frame to allow user stay within a site.

Investment Resources



Logo and Branding

Welcome User User

HomeOutlook 2011Advisor Resource CenterWebcasts For ClientsBroadcastsPublicationsResearchBusiness Daily

Investment Management and Guidance

Home > Advisor Resource Center > Investment ResourcesPrint

Investment Resources

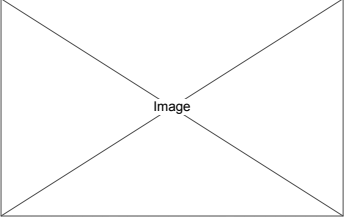



Image

Header

Lorem ipsum dolor sit amet, consectetur adipiscing elit, sed do eiusmod tempor incididunt ut labore et dolore magna aliqua. Ut enim ad minim veniam, quis nostrud exercitation ullamco laboris nisi ut aliquip ex ea commodo consequat. Duis aute irure dolor in reprehenderit in voluptate velit esse cillum dolore eu fugiat nulla pariatur. Excepteur sint occaecat cupidatat non proident, sunt in culpa qui officia deserunt mollit anim id

Tools for Presenting to Clients View all

Tool Name  dolor sit amet, consectetur adipiscing elit, sed do eiusmod tempor incididunt ut labore et dolore magna aliqua. Ut enim ad minim veniam, quis nostrud exercitation ullamco laboris nisi ut aliquip ex ea commodo consequat.

Tool Name  Duis aute irure dolor in reprehenderit in voluptate velit esse cillum dolore eu fugiat nulla pariatur. Excepteur sint occaecat cupidatat non proident, sunt in culpa qui officia deserunt mollit anim id est laborum

Tool Name  Et harum id veniam like Greek to me, dereud facilis est er expedit distinct. Nam liber te conscient to factor tum poen legum odioqueciuida.

Tools for Financial Advisers View all

Tool Name  dolor sit amet, consectetur adipiscing elit, sed do eiusmod tempor incididunt ut labore et dolore magna aliqua. Ut enim ad minim veniam, quis nostrud exercitation ullamco laboris nisi ut aliquip ex ea commodo consequat.

Tool Name  Duis aute irure dolor in reprehenderit in voluptate velit esse cillum dolore eu fugiat nulla pariatur. Excepteur sint occaecat cupidatat non proident, sunt in culpa qui officia deserunt mollit anim id est laborum

Tool Name  Et harum id veniam like Greek to me, dereud facilis est er expedit distinct. Nam liber te conscient to factor tum poen legum odioqueciuida.

Solutions for Business

Contacts See all

Suggestions? - [Email GWM Advice & Guidance](#)

Portfolio Strategies Desk (PSD): (212) 449-5744

[Wealth Management Specialist Directory](#) 

WMB Internal Sales Desk:(888) ML-BANKU (652-2658)

MLSN: (866) ML-SERVICE (657-3784)

[GWM Investment Management & Guidance Website](#) 

Event Calendar See all

Jan 16, 2011

Title

Lorem ipsum dolor sit amet, consectetur adipiscing elit, sed do eiusmod tempor incididunt ut labore et dolore magna aliqua...

[More.....](#)

Your Saved Publications

Most Popular Publications See all

Email Campaign Manager View

Use the Email Campaign Manager to invite Clients & Prospects to watch the client Webcasts.

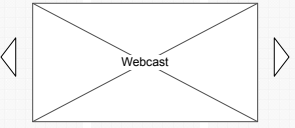

Webcast

IMG Implementation Guide

The Implementation Guide suite matches the best ideas from ML Research with IMG's high conviction implementation:

[Investment By Theme »](#)
[Total Solutions »](#)
[Total Solutions with FA Choice »](#)

Footer

INTERACTION NOTES

Investment Resources page is brought up to the second level navigation (previously the only access was via links in the content)

Webcasts for Clients

Logo and Branding

Welcome User User

Home
Outlook 2011
Advisor Resource Center
Webcasts For Clients
Broadcasts
Publications
Research
Business Daily

Investment Management and Guidance

Home > Webcasts for Clients
Print

Webcasts

Video

Featured Webcast

Date: 00.00.0000 Time: 1.00 Email this webcast to your clients

Lorem ipsum dolor sit amet, consectetur adipisicing elit, sed do eiusmod tempor incididunt ut labore et dolore magna aliqua. Ut enim ad minim veniam, quis nostrud exercitation ullamco laboris nisi ut aliquip ex ea commodo consequat. Duis aute irure dolor in reprehenderit in voluptate velit esse cillum dolore eu fugiat nulla pariatur. Excepteur sint occaecat cupidatat non proident, sunt in culpa qui officia deserunt mollit anim id est laborum Et harum und lookum like Greek to me, dereud facilis est er expedit distinct. Nam liber te conscient to factor tum poen legum odioqueci vuda.

Video

Email this Webcast

Title
Date: 00.00.0000 Time: 00.00

Rure dolor in reprehenderit in voluptate velit esse cillum dolore eu fugiat nulla pariatur.

Video

Email this Webcast

Title
Date: 00.00.0000 Time: 00.00

Rure dolor in reprehenderit in voluptate velit esse cillum dolore eu fugiat nulla pariatur.

Video

Email this Webcast

Title
Date: 00.00.0000 Time: 00.00

Rure dolor in reprehenderit in voluptate velit esse cillum dolore eu fugiat nulla pariatur.

Video

Email this Webcast

Title
Date: 00.00.0000 Time: 00.00

Rure dolor in reprehenderit in voluptate velit esse cillum dolore eu fugiat nulla pariatur.

Video

Email this Webcast

Title
Date: 00.00.0000 Time: 00.00

Rure dolor in reprehenderit in voluptate velit esse cillum dolore eu fugiat nulla pariatur.

Video

Email this Webcast

Title
Date: 00.00.0000 Time: 00.00

Rure dolor in reprehenderit in voluptate velit esse cillum dolore eu fugiat nulla pariatur.

Contacts See all

Suggestions? - [Email GWM Advice & Guidance](#)

Portfolio Strategies Desk (PSD): (212) 449-5744

[Wealth Management Specialist Directory](#)

WMB Internal Sales Desk:(888) ML-BANKU (652-2658)

MLSN: (866) ML-SERVICE (657-3784)

[GWM Investment Management & Guidance Website](#)

Event Calendar See all

Jan 16, 2011

Title

Lorem ipsum dolor sit amet, consectetur adipisicing elit, sed do eiusmod tempor incididunt ut labore et dolore magna aliqua...

More.....

Your Saved Publications

Most Popular Publications See all

Advisor Resource Center

Duis aute irure dolor in reprehenderit in voluptate velit esse cillum dolore eu fugiat nulla pariatur. Excepteur sint occaecat cupidatat non proident, sunt in culpa qui officia deserunt mollit anim id est laborum Et harum und lookum like Greek to me, dereud facilis est er expedit distinct. Nam liber te conscient to factor tum poen legum odioqueci vuda.

view

Email Campaign Manager View

Use the Email Campaign Manager to invite Clients & Prospects to watch the client Webcasts.

Webcast

Footer

INTERACTION NOTES

Overview of available webcasts

Broadcasts

Welcome User User

Home Outlook 2011 Advisor Resource Center Webcasts For Clients **Broadcasts** Publications Research Business Daily Investment Management and Guidance

[Home > Broadcasts](#) [Print](#)

Broadcasts

Featured Broadcast

Date: 00.00.0000 Time: 1.00

Lorem ipsum dolor sit amet, consectetur adipisicing elit, sed do eiusmod tempor incididunt ut labore et dolore magna aliqua. Ut enim ad minim veniam, quis nostrud exercitation ullamco laboris nisi ut aliquip ex ea commodo consequat. Duis aute irure dolor in reprehenderit in voluptate velit esse cillum dolore eu fugiat nulla pariatur. Excepteur sint occaecat cupidatat non proident, sunt in culpa qui officia deserunt mollit anim id est laborum Et harum id lookum like Greek to me, dereud facilis est er expedit distinct. Nam liber te conscient to factor tum poen legum odioqueci vuda.

Title
Date: 00.00.0000 Time: 00.00
Rure dolor in reprehenderit in voluptate velit esse cillum dolore eu fugiat nulla pariatur.

Title
Date: 00.00.0000 Time: 00.00
Rure dolor in reprehenderit in voluptate velit esse cillum dolore eu fugiat nulla pariatur.

Title
Date: 00.00.0000 Time: 00.00
Rure dolor in reprehenderit in voluptate velit esse cillum dolore eu fugiat nulla pariatur.

Title
Date: 00.00.0000 Time: 00.00
Rure dolor in reprehenderit in voluptate velit esse cillum dolore eu fugiat nulla pariatur.

Title
Date: 00.00.0000 Time: 00.00
Rure dolor in reprehenderit in voluptate velit esse cillum dolore eu fugiat nulla pariatur.

Title
Date: 00.00.0000 Time: 00.00
Rure dolor in reprehenderit in voluptate velit esse cillum dolore eu fugiat nulla pariatur.

Contacts

[See all](#)

Suggestions? - [Email GWM Advice & Guidance](#)

Portfolio Strategies Desk (PSD): (212) 449-5744

[Wealth Management Specialist Directory](#)

WMB Internal Sales Desk:(888) ML-BANKU (652-2658)

MLSN: (866) ML-SERVICE (657-3784)

[GWM Investment Management & Guidance Website](#)

Event Calendar

[See all](#)

Jan 16, 2011

Title

Lorem ipsum dolor sit amet, consectetur adipisicing elit, sed do eiusmod tempor incididunt ut labore et dolore magna aliqua...

[More.....](#)

Your Saved Publications

Most Popular Publications

[See all](#)

Email Campaign Manager

[View](#)

Use the Email Campaign Manager to invite Clients & Prospects to watch the client Webcasts.

IMG Implementation Guide

The Implementation Guide suite matches the best ideas from ML Research with IMG's high conviction implementation:

[Investment By Theme »](#)
[Total Solutions »](#)
[Total Solutions with FA Choice »](#)

Footer

INTERACTION NOTES

Overview of available broadcasts

Merrill Lynch Advice & Guidance Web Site
Information Architecture
Published: May 10, 2012
Confidential material.
No distribution without prior permission.

hnw Page 10 of 11

Note: These information architecture layouts are for informational purposes only. All screen sizes are approximate. All visual design elements and copywriting are not final.

Broadcast Detail

Logo and Branding

Welcome User User

HomeOutlook 2011Advisor Resource CenterWebcasts For ClientsBroadcastsPublicationsResearchBusiness DailyInvestment Management and Guidance

[Home > Broadcasts > Details](#) [Print](#)

Broadcast: Title [View all](#)

Video

Title
Date: 00.00.0000 Time: 1.00

Lorem ipsum dolor sit amet, consectetur adipisicing elit, sed do eiusmod tempor incididunt ut labore et dolore magna aliqua. Ut enim ad minim veniam, quis nostrud exercitation ullamco laboris nisi ut aliquip ex ea commodo consequat. Duis aute irure dolor in reprehenderit in voluptate velit esse cillum dolore eu fugiat nulla pariatur. Excepteur sint occaecat cupidatat non proident, sunt in culpa qui officia deserunt mollit anim id est laborum Et harum id lookum like Greek to me, dereud facilis est er expedit distinct. Nam liber te conscient to factor tum poen legum odioqueci vuda.

Lorem ipsum dolor sit amet, consectetur adipisicing elit, sed do eiusmod tempor incididunt ut labore et dolore magna aliqua. Ut enim ad minim veniam, quis nostrud exercitation ullamco laboris nisi ut aliquip ex ea commodo consequat. Duis aute irure dolor in reprehenderit in voluptate velit esse cillum dolore eu fugiat nulla pariatur. Excepteur sint occaecat cupidatat non proident, sunt in culpa qui officia deserunt mollit anim id est laborum Et harum id lookum like Greek to me, dereud facilis est er expedit distinct. Nam liber te conscient to factor tum poen legum odioqueci vuda.

Lorem ipsum dolor sit amet, consectetur adipisicing elit, sed do eiusmod tempor incididunt ut labore et dolore magna aliqua. Ut enim ad minim veniam, quis nostrud exercitation ullamco laboris nisi ut aliquip ex ea commodo consequat. Duis aute irure dolor in reprehenderit in voluptate velit esse cillum dolore eu fugiat nulla pariatur. Excepteur sint occaecat cupidatat non proident, sunt in culpa qui officia deserunt mollit anim id est laborum Et harum id lookum like Greek to me, dereud facilis est er expedit distinct. Nam liber te conscient to factor tum poen legum odioqueci vuda.

Footer

INTERACTION NOTES

Broadcast Detail page allows for high quality viewing of the selected broadcast

Recommendation: embed video within a page